

BANZAI

NITRO

1/10 SCALE 4WD READY-TO-RUN
NITRO POWERED DRIFT STREET CAR



ENGLISH INSTRUCTIONS – PAGE 2
FRANÇAIS INSTRUCTIONS – PAGE 13

SET-UP INSTRUCTIONS AND PARTS LISTING

www.ftx-rc.com





FTX BANZAI NITRO 1/10TH SCALE 4WD READY-TO-RUN DRIFT STREET CAR

Congratulations on your purchase of the FTX Banzai Nitro 1/10th Scale 4wd Ready-To-Run Drift Street Car¹.

This 1/10th scale model has been factory assembled and all electrics installed and set up to make it the easiest possible introduction to the sport of driving RC cars.

WARNING: Read the ENTIRE instruction manual to become familiar with the features of the product before operating.

Failure to operate the product correctly can result in damage to the product, personal property and cause serious injury.

This is NOT a toy and must be operated with caution and common sense.

Failure to operate this product in a safe and responsible manner could result in damage, injury or damage to other property.

This product is not intended for use by children without direct adult supervision.

It is essential to read and follow all the instructions and warnings in the manual, prior to assembly, set-up or use, in order to operate correctly and avoid damage or serious injury.

Safety Precautions and Warnings

- You are responsible for operating this model such that it does not endanger yourself and others, or result in damage to the product or the property of others.
- This model is controlled by a radio which is possibly subject to interference which can cause momentary loss of control so it is advisable to always keep a safe distance to avoid collisions or injury.
- Age Recommendation: 14 years or over. This is not a toy. This product is not intended for use by children without direct adult supervision.

Carefully follow these directions and warnings, plus those of any additional equipment associated with the use of this model, fuel, starting equipment, engine, radio etc.

- Never operate your model with low transmitter batteries.
- Always operate your model in an open area away from cars, traffic or people.
- Never operate the model in the street or in populated areas.
- Always keep the vehicle in direct line of sight, you cannot control what you cannot see!
- Keep all chemicals, small parts and anything electrical out of the reach of children.
- Although the model includes waterproof servos and receiver, the model and engine are not suited to extensive running in wet weather conditions. Long term damage can occur to the model and particularly the engine if run in prolonged wet conditions.
- Avoid injury from high speed rotating parts, gears and axles etc.
- Novices should seek advice from more experienced people to operate the model correctly and meet its performance potential.
- Exercise caution when using tools and sharp instruments.
- Do not put fingers or any objects inside rotating and moving parts.
- Take care when carrying out repairs or maintenance as some parts may be sharp.
- Do NOT touch equipment such as the engine heatsink head and exhaust pipe, immediately after using your model because they can generate high temperatures.
- Always turn on your transmitter before you turn on the receiver in the car. Always turn off the receiver before turning your transmitter off.
- Keep the wheels of the model off the ground, and keep your hands away from the wheels when checking the operation of the radio equipment or engine set-up.
- Prolong engine life by following the engine set-up and guidelines outlined within the manual.

Contents:

- FTX Banzai Nitro Street Car
- Etronix Pulse Radio

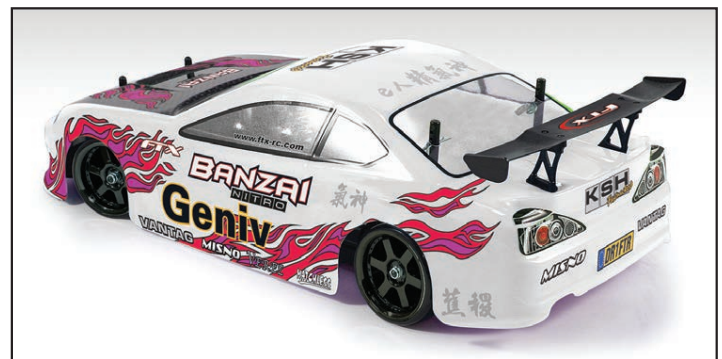



ITEMS NOT INCLUDED BUT REQUIRED EQUIPMENT FOR OPERATION



8 x AA batteries

Air Filter Oil



Fuel Bottle



Glow Igniter

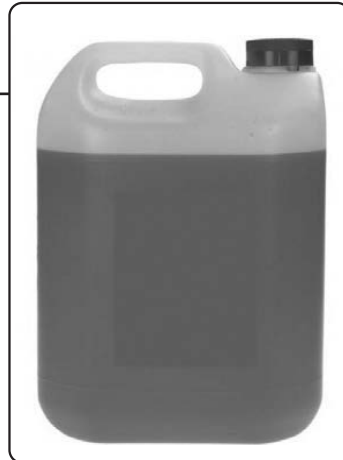

Nitro Fuel

RECOMMENDED TOOLS FOR COMPLETION

FAST615
Fastrax 7-Piece Tool Set



Includes 1.5mm, 2.0mm, 2.5mm, 3.0mm hex wrenches, slotted and phillips screwdriver.



FAST625 Cross Wrench
Five different hex sizes 7mm, 8mm, 10mm, 12mm & 17mm meet a variety of tightening and loosening applications for glow plugs, wheel nuts and bolts. Can also store 4 glow plugs, in centre section.



FAST692 Nitro Starter Set
The perfect set up pack includes glow starter and charger, fuel bottle, screwdrivers and cross wrenches.



GETTING TO KNOW YOUR TRANSMITTER

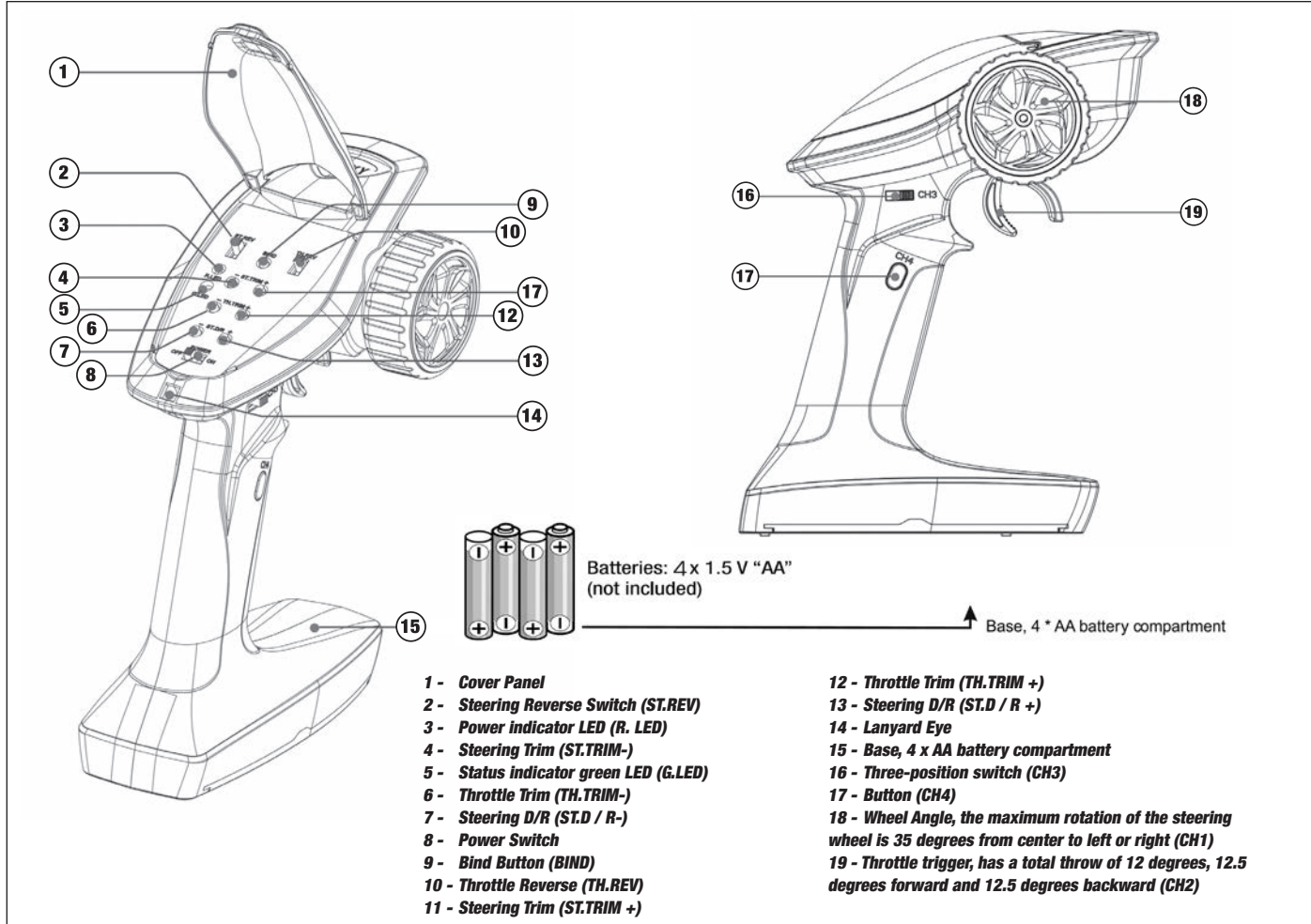

Receiver Overview

To ensure the best signal quality make sure that the receiver is mounted in such a way that the antenna is in the upright, vertical position.

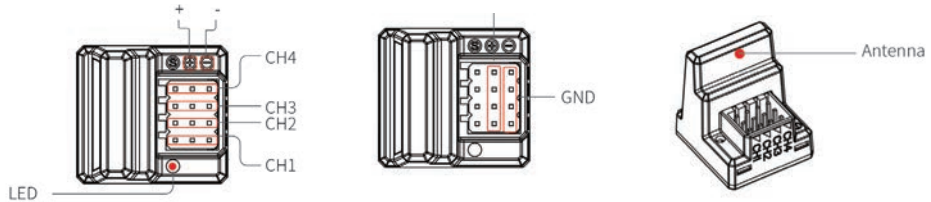

Battery installation

1. Open the battery compartment cover.
2. Insert 4 fully-charged AA batteries into the compartment. Make sure that the battery makes good contact with the battery compartment's contacts and that they are inserted with the correct polarity.
3. Replace battery compartment cover.

NOTE:

The transmitter features a low battery alarm: When the battery is lower than 4.2v, the G.LED on the panel will flash slowly.

Binding

To ensure the best signal quality make sure that the receiver is mounted in such a way that the antenna is in the upright, vertical position.

The transmitter and receiver have already been bound at the factory.

1. Turn on the transmitter while holding the bind button to enter bind mode. G.LED will start flashing quickly. Once in bind mode release the bind button.
2. The receiver will enter bind mode automatically when powered on.
3. Once binding is successful the receiver's LED will flash slowly and the transmitter's LED will remain solid after being rebooted.

NOTE:

When binding, put the transmitter into bind mode first, then the receiver.

Stick Calibration

This function is used to set the neutral position for throttle and steering.

Every transmitter is calibrated before leaving the factory, however if recalibration is required, please follow these steps:

1. Turn and hold the wheel as far clockwise as it will turn, push the throttle trigger all the way forward, then turn on the transmitter in calibration mode.
 - The R.LED and G.LED will flash twice.
2. Calibrate steering: Turn the wheel completely clockwise, then completely counter-clockwise.
 - When calibration is complete the R.LED will turn off.
3. Trigger calibration: Pull the trigger back then forward as far as it will go.
 - When calibration is complete the G.LED will turn off.
4. Once calibration is complete press the bind key to save and exit.



RUNNING YOUR CAR

1. TURNING ON THE RECEIVER OF YOUR CAR

The switch is mounted inside the receiver box under a rubber cover.

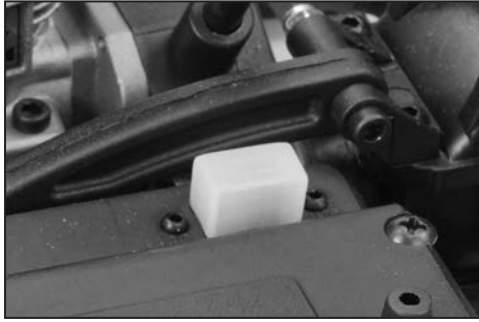

2. TURN ON THE RADIO CONTROLLER

Switch on the power switch on the radio controller. Your radio is bound with your car automatically.



3. CHECK STEERING PERFORMANCE

CENTRE

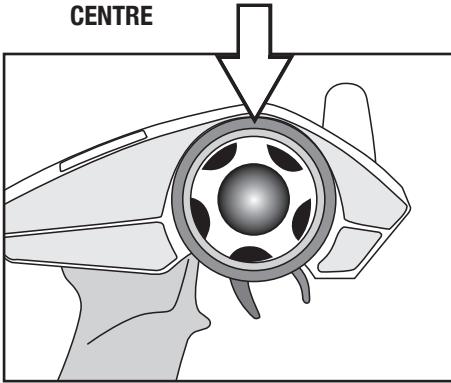

1. To keep the car running straight, keep the steering wheel centered.

TURN RIGHT

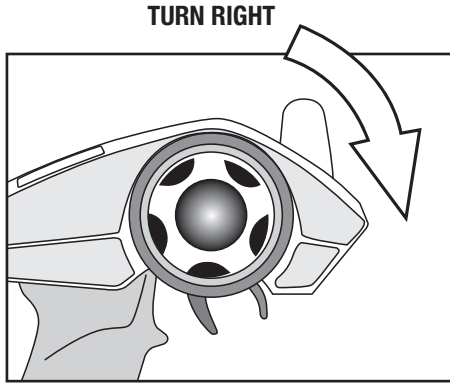

2. Turn the steering wheel to the right to allow the car to right.

TURN LEFT

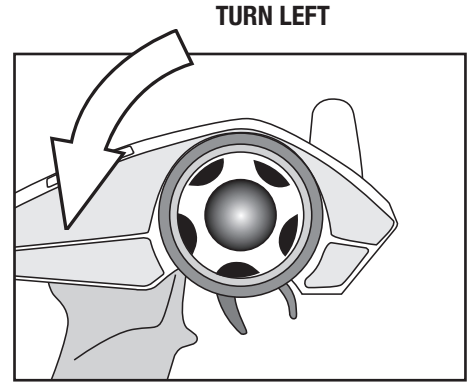

3. Turn the steering wheel to the left to allow the car to turn to the left.

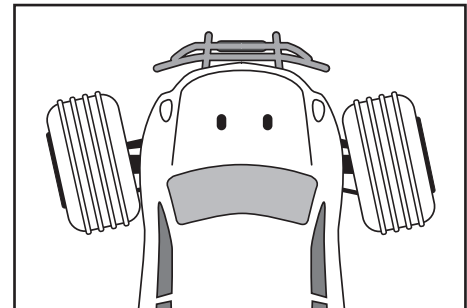
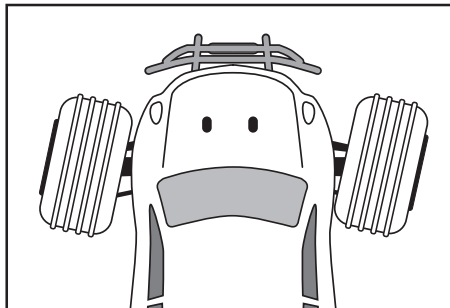
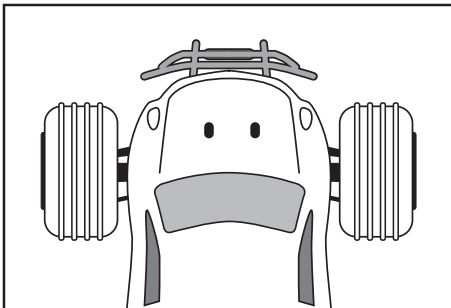

4. CHECK TRIGGER RESPONSE

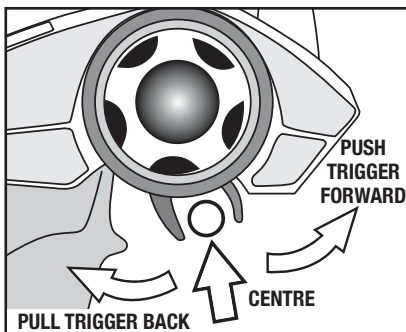

PLEASE NOTE: THE MODEL SWITCHES BETWEEN FORWARD AND REVERSE INSTANTLY FOR SLOW SPEED MANOEUVABILITY. EXCESSIVE USE OF THIS FEATURE CAN CAUSE TRANSMISSION AND ESC DAMAGE.

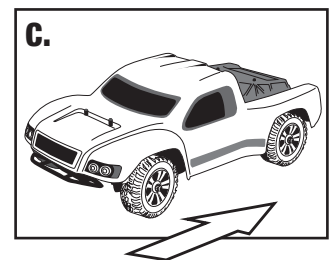
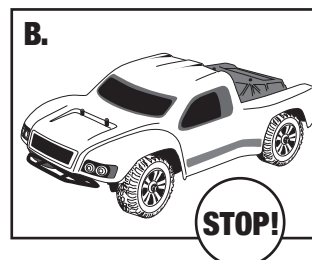
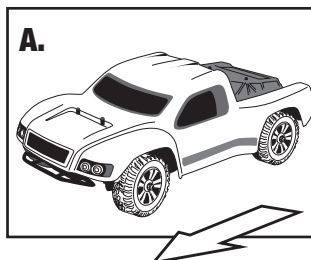

A. Pull the trigger back to accelerate, release it to decelerate.
B. To stop running your car, release the trigger to neutral.
C. Pushing the trigger forward activates brake.



RUNNING YOUR CAR

5. TUNING THE STEERING TRIM

STEERING TRIM BUTTONS

Gently pull the trigger to allow your car to run slowly. Meantime, tune the steering trim to allow the front wheels to be aligned by pressing the left or right buttons.



STEERING

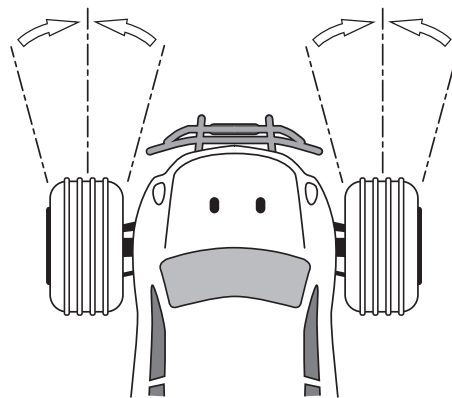

6. TUNING THE THROTTLE TRIM

THROTTLE TRIM BUTTONS

Throttle Trim is used to set the idle speed of the car, by pressing the left or right buttons.



THROTTLE TRIM

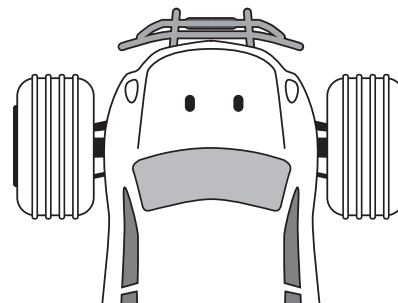

LED INDICATOR:

- When using the trim keys the G.LED will flash slowly for short presses and quickly on long presses.
- When the adjustment value is at the midpoint, the G.LED will flash twice slowly.
- When the adjustment value is at the end of either + or - , the trim adjustment is at its maximum and as such G.LED will not flash.

7. TO TUNE THE STEERING DUAL RATE CONTROL DIAL

STEERING D/R KNOB:

The buttons marked "ST/DR" is for servo travel adjustment. You should adjust this to give maximum steering without straining the servo.

Adjustment range: 0-120%(the default is 100%), the step is 5%.

ST.D / R + : increase servo travel.

ST.D / R - : decrease servo travel.



STEERING D/R

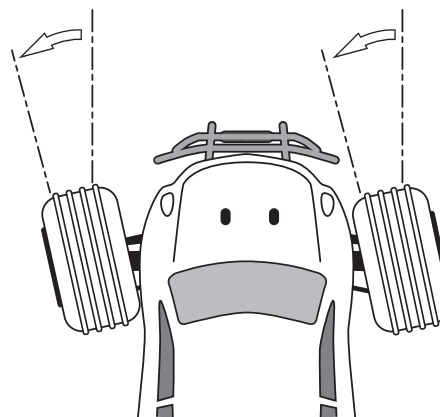

LED INDICATOR:

- When using the trim keys the G.LED will flash slowly on short presses and quickly on long presses.
- When the adjustment reaches the end point the G.LED will no longer flash.

8. STEERING/THROTTLE REVERSE

This function is used to adjust each channels direction of movement in relation to it's input .

The ST.REV/TH.REV switches are the reverse buttons for CH1 and CH2. If the switch is up it indicates reverse, down indicates normal..

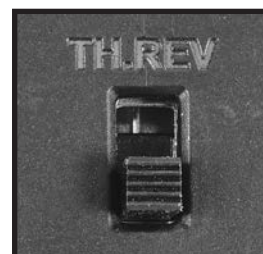
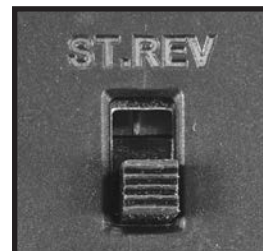



QUICK START GUIDE



Step 1
Install 4 "AA" batteries into the transmitter as per the Etronix instruction booklet noting the proper direction of each cell.



Step 2
Open the radio box and Install 4 "AA" batteries in the battery holder noting the proper direction of each cell.



Step 3
Insert the antenna tube in the top of the radio box. Feed the receiver antenna through the tube until several inches extend out the top. Install the antenna tip. If you choose to cut the tube down to size, do so without the antenna installed.

Step 4
Turn on the transmitter and then the receiver. Check to make sure that the servos are operating correctly and that the carburetor closes when the throttle trigger is released.

AT THIS POINT PLEASE FOLLOW THE SEPARATE ETRONIX RADIO INSTRUCTION BOOKLET FOR RADIO SET-UP. MAKE SURE THAT YOU SET THE FAILSAFE FEATURE ON THE TRANSMITTER.



Step 5
Apply air filter oil to help keep the dirt out. The best method is to remove the end cap (keep the filter connected to the carb) and remove the foam element. Dab the treatment all around the filter, put the filter in a plastic sandwich bag, and knead it until the filter is saturated, but not soaked.



Step 6
Starting the Engine
You MUST read the engine running in guidelines and set-up on pages 9-12 before trying to start your engine. Below is a quick overview of the starting procedure once the engine is RUN-IN.

1. Before attempting to start the engine from cold, remove the glow-plug with an 8mm nut driver prime the engine with fuel pull the pull-starter rapidly with your finger over the exhaust pipe outlet (IMPORTANT- only when cold!) until the fuel has travelled to the carb, and then a further 10-20 times to lube the engine.

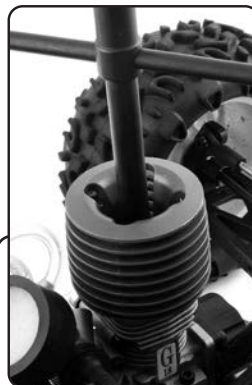

Do not extend fully the pull start beyond. Keep the extension to around 20cm with short sharp pulls.

Do not extend fully the pull start beyond.



(please not images of FTX Carnage Nitro used for illustration purposes)



2. Then turn the car upside down and pull the pullstarter rapidly until all the excess fuel has emptied onto the floor through the glowplug hole. Make sure you do this outside safely. This process is really only necessary when the engine is cold or brand new and tight.

Refit the plug ensuring the copper gasket washer is also refitted. Wind it all the way in and then re-wind 1 to 1.5 turns. This allows gases to escape thus lowering the engines initial compression.

NB: Images of Carnage NT used for illustration purposes.

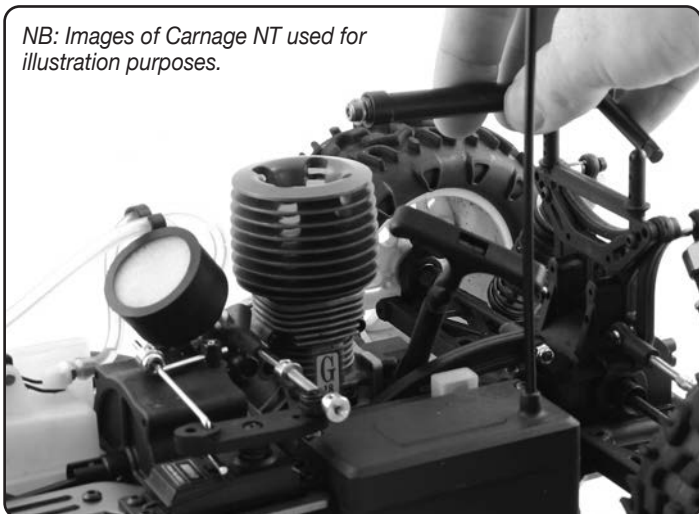

3. Start engine. Add fuel to the fuel tank using a suitable fuel bottle.

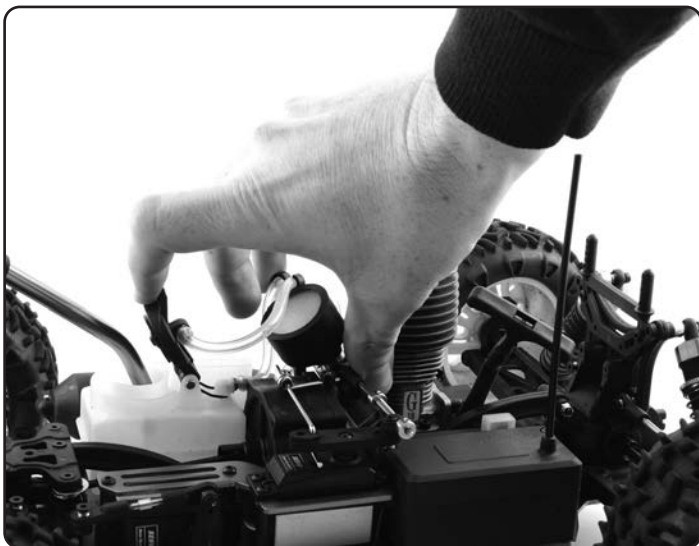

Use a glow plug heater to ignite the engine plug as illustrated and start to pull the the pull starter (be careful not to extend too far as mentioned previously). Ensure you have a small amount of carburetor open (around 2mm) to allow for air intake to help starting.

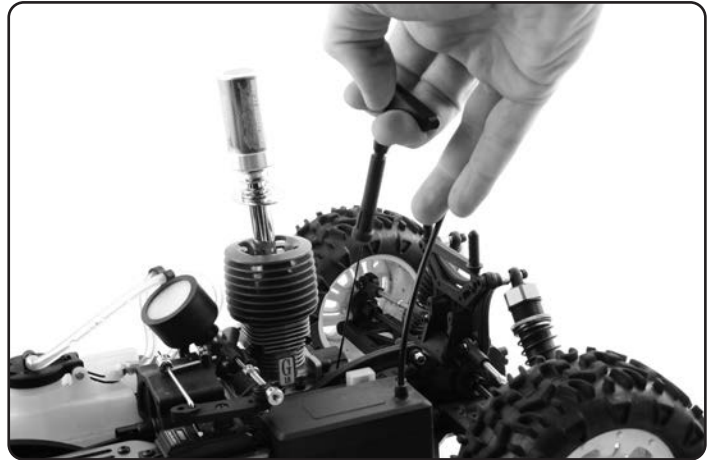

IMPORTANT

- make sure the car is secured or off the ground while attempting to start.

The engine will run "lumpily" or stop after a few seconds so try and keep it running by blipping the throttle. Tighten the glowplug while the engine is running if possible. If the engine has stalled restart with the plug tightened. The above procedure should always be followed from cold or if difficulty with starting is being experienced.



4. Stopping the engine. To stop the engine either use a stop tool to cover the exhaust outlet or use a flywheel stop tool.

IMPORTANT - Do not use fingers as the exhaust will be HOT and the flywheel ROTATING!

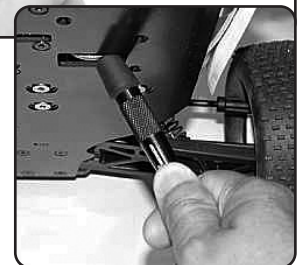

Warning! Flooding of the Engine

The most common cause of engine and pullstarter damage is from the "flooding" of the engine or a hydro-lock. More accurately this is too much fuel inside the engines crankcase causing the piston to lock. The piston rises to the top of the combustion chamber and instead of compressing a gas i.e. fuel/air mixture it has to try and compress a liquid, fuel only, which isn't possible. This puts massive strain on the piston, conrod and crankshaft as well as the starter. Invariably one component will fail, usually the conrod causing massive damage to the engines internals.

To avoid flooding the engine, always start the engine from cold using the methods mentioned above and if at any time the engine becomes difficult to turn over with the pullstarter, then remove the glowplug and empty all excess fuel out and start again. The pullstarter assembly can only be damaged by either over extension or a flooded engine. So if you break a pull start this is possible warning of a flooded engine.

(please not images of FTX Carnage Nitro used for illustration purposes)



Force .18 Nitro Engine Information

IMPORTANT - READ THIS BEFORE STARTING YOUR ENGINE!

For your safety - Your engine is not a toy!

- You will be working with highly flammable fuel, so keep it away from exposed flames or any thing which might ignite it. Read the safety info on the fuel container.
- Do not use fuels that were not designed for glow plug engines.
- Keep the fuel out of reach of children!
- Deadly carbon monoxide gas will be released, so do not operate the engine in an enclosed area where exposed flames or sparks can ignite it, or where it causes you to inhale it for prolonged periods.
- During operation, the engine may be dangerously hot to the touch
- Do not use the engine for purposes other than in model cars designed for them.
- Mount the engine securely.

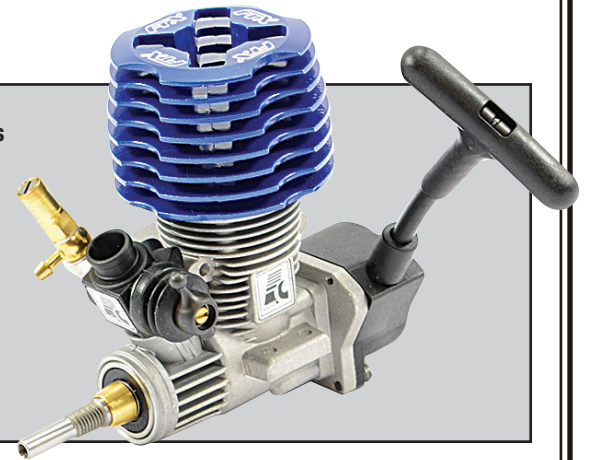

Before Starting Your Engine

Oiling the filter

The air filter is essential for keeping dirt out of the engine. A foam filter must be oiled before running the engine. We recommend using Fastrax FAST63 Filter Oil treatment. Dab the treatment all around the filter, put the filter in a plastic bag and knead it until the filter is saturated, but not soaked. NEVER RUN YOUR VEHICLE WITHOUT THE AIR FILTER.

Adjustments

Your engine has come factory set to allow for an easy start and rich running . DO NOT alter any of the settings until the running in period has been completed.

Putting fuel in the fuel tank

Squeeze the fuel bottle, put the bottle's tube into your fuel container, and draw out some fuel. Lift up the lid on the fuel tank, and slowly squeeze the fuel bottle until the tank is full. Be careful here. If you overflow the tank it might get on your radio gear or on your brakes and you may create an unsafe driving situation. Always keep your fuel bottle closed when not in use.

Understanding the engine terms "rich" and "lean"

Your carburettor has screws that regulate how much air and fuel enter the engine together, the air/fuel mixture. An air/fuel mixture that is too "rich" means there is too much fuel, and a mixture that is too "lean" means that there is not enough fuel for the given amount of air. When the mixture is too rich, performance will be sluggish (one symptom of this, is excessive amounts of smoke from the exhaust). There is also a potential to foul the glow plug when the mixture is too rich. When the mixture is too lean, there is not enough fuel to cool or lubricate the internal engine components, and damage to the engine and/or glow plug is almost certain.

CAUTION:

If, while you are driving, the engine stalls because of an overheating condition, severe damage may have already occurred. Overheating is caused by the following conditions.

- Fuel mixture is set too lean
- Air leak around carb
- Loss of muffler pressure (line falls off)
- Excessive nitro content in the fuel
- Incorrect oil content in the fuel
- No air filter
- Poor quality of fuel
- Contaminated fuel
- Excessive loads on the engine (locked drivetrain)

Your engine will be short-lived if any of the above conditions are allowed to exist for any length of time. During the first few tanks watch closely for any signs of overheating. These will include:

- Steam or smoke coming from the engine surfaces
- Cleaning out and then lagging during high-speed acceleration, as if it is running out of fuel.

- Popping or clattering sound when slowing down.
Idle speed will surge or possibly diminish to the point of stalling.

To Test For Overheating

It's important to check the head temperature during the operation of the engine. The best method for checking the head temperature is to use a head temperature gauge. There are several head temperature gauges available, and the temperature readings between these different brands of gauges vary. Due to this variance , the temperature readings will range between approximately 185 degrees and 225 degrees. About 185 degrees is the normal for the GO.18. If you don't have access to a head temperature gauge, you can use water to check the head temperature. Place a drop of water on top of the cylinder head. If it sizzles away immediately, shut down your engine. If it takes approximately 3-5 seconds for the water drop to boil away, then the engine is running within a normal temperature range.

Start Your Engines

Running-In

The modern model car engine requires relatively little running in, due to the use of ABC piston and liner assembly. The engine should be run on a rich setting for approximately 6-8 tanks of fuel, with another 6-8 at a slightly less rich setting. Once this has been completed, the internal engine components should be properly seated and a normal setting can be used.

A good idea is to use a running in fuel as it is especially designed for breaking in new engines without damage.

The best methods of checking on the running setting of the engine, is to first check the smoke trail coming out of the exhaust with the car is running. A very rich setting would allow the car to pull away slowly or sluggish with a momentary hesitation and lots of smoke from a standing start. When the car is accelerating at full throttle, the engine will never "Clean Out". When an engine cleans out, the speed and the rpms will increase suddenly and dramatically, as if the engine has switched to second gear. Also, the amount of smoke that comes from the exhaust will decrease. Cleaning Out is a desirable characteristic once the engine is fully broken in.

As the engine reaches normal operating temperature, it will speed up and performance will increase. This occurs because the fuel mixture is becoming leaner with the increased temperature. You will need to richen the fuel mixture so that the engine continues to run as described above. When the first tank is almost gone, bring the car in and shut off the engine. Allow the engine to cool for 8 to 10 minutes before starting the engine up again. Add more fuel. Start it back up and run the second tank of fuel. Again allow the engine to cool before starting it up again.

The key to breaking in your engine is patience. During the break in period , your engine may appear to malfunction with problems such as stalling, inconsistent performance, and fouling out glow plugs. Don't give up.



These are just a few things you may go through during the break in period. Just keep it running, apply the throttle on and off as smoothly as you can. Sudden bursts or quick releases of the throttle can stall your engine. Soon after break in your patience will pay off with a well running engine. The performance level of the engine will be limited by the "rich" fuel mixture which you will use all during the break-in process. Once the engine is fully broken-in the mixture can be "leaned out," and speed and acceleration will increase. Because of the rich fuel mixture and the wearing of the new parts, deposits will form on the glow plug causing it to fail. Expect to replace the glow plug during the break in period, and definitely when the engine is fully broken in and the fuel mixture is leaned out.

Setting Engine for Normal Tuning High Speed

As you approach the first 6-8 tanks running you can start to GRADUALLY adjust you engine for normal performance. PLEASE NOTE any adjustments need to be very small at 1/8th turn increments. You can then begin adjusting the fuel mixture to maximize performance for your driving needs. To lean turn the main fuel control needle in a clockwise direction. This will allow the car to pull away faster and more cleanly, without hesitation and increase the top speed. There should however still be a noticeable smoke trail.

If the main needle is screwed in too far thus allowing the engine to run too lean, it will seem to run strong at first, but will bog, hesitate, or stall when running at high speed. The engine will also rapidly overheat when the setting is too lean. This is because fuel includes lubrication, and that lubrication is inadequate when the setting is too lean. CHECK THE ENGINE TEMPERATURE OFTEN AS YOU LEAN THE MIXTURE. DO NOT LET THE ENGINE OVERHEAT. You should always see smoke coming from the exhaust.

At the optimum setting, the engine will clean out; have a strong-sounding, high-pitched whine at full speed; and there will be a thin trail of whitish smoke coming from the exhaust. It is always better to set the engine a little rich rather than too lean.

If the engine stalls on acceleration, begins to bog or slow down at full throttle, or if there is a reduction in exhaust smoke, then the engine is running too lean. Immediately turn the high speed mixture screw counterclockwise 1/4 of a turn and operate the car at medium speeds for 1 to 2 minutes to allow the engine to cool.

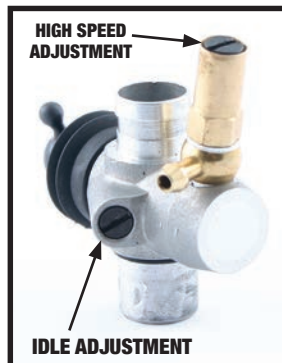

Tuning Low Speed

The low-speed mixture affects how the engine will perform in the low to mid range rpms. Turning the low-speed needle clockwise will lean the mixture. As with the high-speed mixture, leaning the low-speed mixture increases performance. Again, if the mixture here is set too lean, the engine may be starved for lubrication in the low and mid-rpm ranges, thus causing overheating and excessive engine wear.

Perform the following test to determine if the low speed mixture is set correctly. With the engine warm and running, allow it to idle for approximately 15 seconds. Now quickly apply throttle and note the performance. If the engine bogs, accelerates erratically, and a large puff of blue smokes emitted, then the low speed mixture is too rich. Turn the low-speed screw clockwise 1/8 of a turn. If the engine speeds up for a moment then bogs, hesitates, or stalls, then the low speed mixture is too lean. Turn the screw counterclockwise 1/8 of a turn. Adjust the mixture screws in 1/8 of a turn increments, wait 15 seconds, and retest after each change. Adjust for the best acceleration without the car stalling.

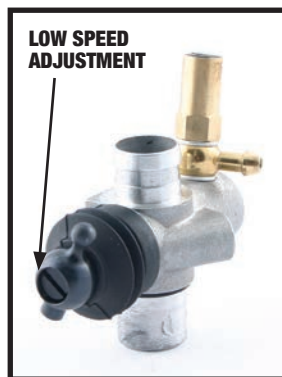

Care and Maintenance

When you are finished racing for the day, drain the fuel tank. Afterwards, energize the glow plug with your glow plug starter and try to restart the engine

in order to burn off any fuel that may remain inside the engine. Repeat this procedure until the engine fails to fire. Try to eject residue while the engine is still warm. Finally, inject some corrosion inhibiting oil, and rotate the engine to distribute the oil to all the working parts. Do not, however, inject the oil into the carburetor, for it may cause the O-rings inside to deteriorate. When cleaning the exterior of the engine, use WD-40. Do not use gasoline or any solvents that might damage the silicone fuel tubing.

Cleaning the air filter. When the air filter starts to get dirty, do the following steps:

- Step 1. Clean the foam with fuel. Do this by pouring a little fuel in a small can and kneading the filter in the fuel. When it looks cleaner, then dispose of the fuel.
- Step 2. Dry the filter. Squeeze out the fuel with a paper towel until it's dry.
- Step 3. Fastrax Fast63 Filer Oil to help keep the dirt out. Dab the treatment all around the filter, put the filter in a plastic sandwich bag, and knead it until the filter is saturated, but not soaked.



Troubleshooting Glow Plug Problems

The glow plug in your engine is an inexpensive consumable item which must be replaced periodically to maintain peak performance and starting ease. Most often, any starting problems or erratic performance can be traced back to the glow plug. The glow plug should also be checked if the engine's acceleration and top speed performance suddenly becomes flat. The only sure way to test for a faulty glow plug is simply install a new one to see if the problem goes away. Remove the plug from the cylinder head with a 8mm nut driver. Make sure there is no dirt or debris on top of the head which could fall into the engine. Do not loose the copper gasket which seals the glow plug. Touch the glow plug to the contacts of the glow plug starter. All of the coils should glow white. Sometimes the first few coils will not glow while the rest are bright, most likely indicating a bad plug. If the glow is dim orange, then the glow starter battery should be replaced or recharged.

At the high rpm that the engines operate only a top quality plug will cut the mustard. Therefore we recommend the use of the Fastrax Platinum No.4 glowplug (FAST760-4).

Fuel Mixture

The fuel mixture is the largest variable you have to control while operating your engine.

Fuel brand, ambient temperature, and humidity all effect how your mixture should be set. If the engine runs great one day but runs rich or lean the next day, it is probably the result of a change in the air quality and temperature. This should be expected and adjusted for.

Although there are many fuels on the market, very few are designed to perform and protect your engine at the likes of 35,000rpm that some of our engines can attain.

Keep between 16-20% nitromethane content for running and first use. The single most popular reason for engine failure or unreliability is poor or wrong fuel.





Pull Starter Hints

The pull starter as fitted to most of the entry level engines is, if treated correctly, the easiest and most cost effective method of starting an engine. As with every silver lining, there is a cloud. The pullstart system is similar to that of a lawnmower to look at, but that is where the similarity ends. The pullstarter is susceptible to breaking if the engine is flooded or not lubricated enough. To ensure this does not happen, a few simple rules should be followed.

1. Before attempting to start the engine from cold, remove the glowplug and then prime the engine with fuel. For cars with a primer button on the tank, press this until the fuel has travelled along the fuel pipe to the carburettor and then a further 10-20 presses. For cars without a primer on the tank, pull the pullstarter rapidly with your finger over the exhaust pipe outlet until the fuel has travelled to the carb, and then a further 10-20 times to lube the engine.
2. Then turn the car upside down and pull the pullstarter rapidly until all the excess fuel has emptied onto the floor through the glowplug hole. Refit the plug ensuring the copper gasket washer is also refitted. Wind it all the way in and then re-wind 1 to 1.5 turns. This allows gases to escape thus lowering the engines initial compression.
3. Start engine. The engine will run "lumpily" or stop after a few

seconds so try and keep it running by blipping the throttle. Tighten the glowplug while the engine is running if possible. If the engine has stalled restart with the plug tightened.

The above procedure should always be followed from cold or if difficulty with starting is being experienced.

Flooding of the Engine

The most common cause of engine and pullstarter damage is from the "flooding" of the engine or a hydro-locked. More accurately this is too much fuel inside the engines crankcase causing the piston to lock. The piston rises to the top of the combustion chamber and instead of compressing a gas i.e. fuel/air mixture it has to try and compress a liquid, fuel only, which isn't possible. This puts massive strain on the piston, conrod and crankshaft as well as the starter. Invariably one component will fail, usually the conrod causing massive damage to the engines internals.

To avoid flooding the engine, always start the engine from cold using the methods mentioned above and if at any time the engine becomes difficult to turn over with the pullstarter, then remove the glowplug and empty all excess fuel out and start again. The pullstarter assembly can only be damaged by either over extension or a flooded engine. So if you break a pull start this is possible warning of a flooded engine.

Description	Problem	Solution
Engine will not start	Out of fuel Improper or contaminated fuel Glow starter not charged Glow plug bad Engine flooded Engine overheating Carburetor incorrectly adjusted Exhaust blocked Air cleaner blocked	Fill fuel tank Replace fuel Charge glow starter Replace glow plug, see "Glow Plug Problems" See "flooding" section. Allow engine to cool, richen fuel mixture, check airflow Readjust carburetor Clean exhaust system Clean air filter
Starter will not pull	Engine is flooded Rope is jammed Engine seized	Clear excess fuel, see "flooding" Section. Repair starter. Examine engine for damage.
Engine starts and then stalls	Idle speed set too low Air bubbles in fuel line Glow plug is fouled Engine is overheated Insufficient fuel tank pressure Blockage at exhaust header fitting	Increase idle speed. Check for holes in the fuel line. Replace glow plug, see "Glow Plug Problem" section. Allow engine to cool, richen fuel Mixture, check airflow Replace pressure hose- clear Check flow to and from the tank.
Engine sluggish / poor performance	High-speed fuel mixture is too rich Leaking glow plug Fuel bad or contaminated Carburetor dirty or blocked Engine overheating Engine over geared for application Clutch slipping Bound up drive train	Set high-speed mixture to a leaner setting Check glow plug gasket Replace fuel Clean Carburetor Stop the engine- find the cause Use a lower gear ratio Replace clutch shoes Find the bound item and repair
Engine overheats	High-speed fuel mixture is too lean Cooling air is being blocked Excessive nitro in the fuel Excessive load on the engine Low-speed mixture too lean	Richen high-speed mixture Get air to the head Use fuel with lower nitro Check for bound up drive train Richen low-speed mixture
Engine hesitates or stumbles	High-speed mixture too lean Low-speed mixture too rich Engine overheated Air bubbles in fuel line Glow plug fouled	Richen high-speed mixture. Lean low-speed mixture. Stop the engine and find the cause. Check for holes in fuel line. Test or replace plug
Engine stalls instantly when throttle is fully opened from idle	Glow plug fouled Low-speed mixture too lean High-speed mixture too rich	Replace glow plug. Richen low-speed mixture. Lean high-speed mixture.
Engine stalls while driving around turns	Fuel level is low Idle speed set too low	Add fuel Increase idle speed.



Cooling Problems

Engine overheating is most often caused by running the engine too lean or because the cooling air for the cylinder head is blocked. If the mixture is too lean, simply allow the engine to cool, richen the mixture and try it again. Bodies must have holes cut in them to allow for cooling air to circulate over the surface of the cylinder head. On most bodies, it is a good idea to cut part of the wind-shield out and part of the back window to allow for additional cooling.

Factory Settings for Force .18

All new engines are assembled with what we will term 'factory settings'. These settings should allow almost all engines to be started up and allow for minimal adjustment for running in purposes.

Bearing this in mind, we are offering you the opportunity of re-adjusting to the 'factory settings' based on engines currently held in stock.

Main Needle Valve – High Speed Adjustment (HSA)

Screw down until resistance is met, and no further movement is apparent. RE-OPEN 3 1/4 TURNS.

Throttle Adjustment Screw – Idle Adjustment (IA)

Gently shut off carburettor sliding body and slowly re-open by means of adjusting screw.

ADJUST SCREW UNTIL APPROX 1 or 1 1/4mm OF APERTURE APPEARS BETWEEN THE END OF THE THROTTLE BODY AND AIR INTAKE APERTURE.

Sub Throttle Needle Valve – Low Speed Adjustment (LSA)

With adjustment screw setting in place, close off the throttle body against the screw. Very gently screw in the needle valve until it closes off the supply fuel nozzle and is prevented from re-opening by the entry of the needle valve into the centre hole of the fuel nozzle (work with great care with this one - we are only looking for minimal frictional contact between both parts).

RE-OPEN VALVE 2 1/2 TURNS.

Glossary of Carburettor Functions

Main Needle Valve (High Speed)

The main needle mixture screw controls how much fuel enters the engine during mid- to high-speed operation. The screw is turned clockwise to lean (less fuel) and anti-clockwise to richen (more fuel)

Sub Throttle Valve (Low Speed)

This screw meters the fuel at low speeds. The low-speed mixture screw is located in the end of the carburetor, inside the throttle arm.

This screw controls how much fuel enters the engine at idle and low throttle. This adjustment will smooth the idle and improve the acceleration to mid speed. Make this adjustment with the throttle closed, after setting the idle. The screw is turned clockwise to lean (less fuel) and anti-clockwise to richen (more fuel)

Throttle Adjustment Screw

The throttle adjustment screw regulates the throttle opening to control the idle speed. The screw is turned clockwise for a higher idle speed and anti-clockwise for a lower idle speed.

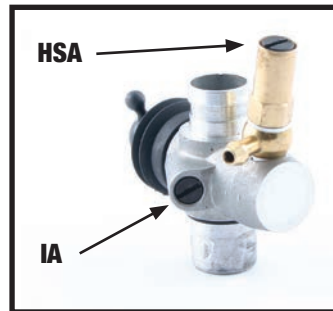

FORCE .18 PULL START ENGINE

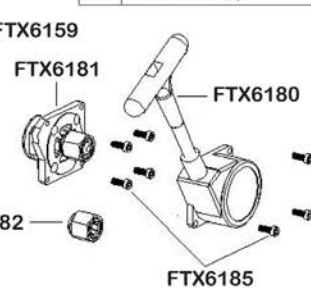
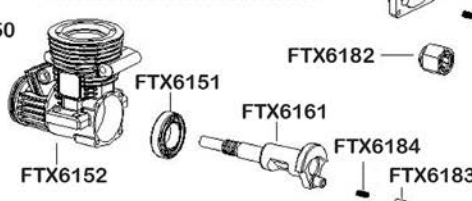
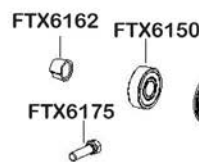
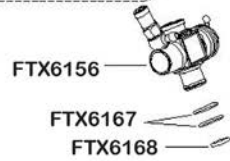
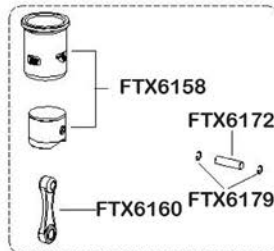
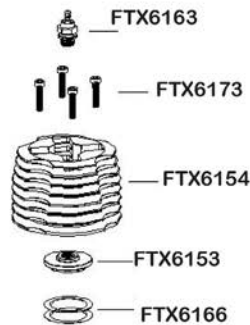
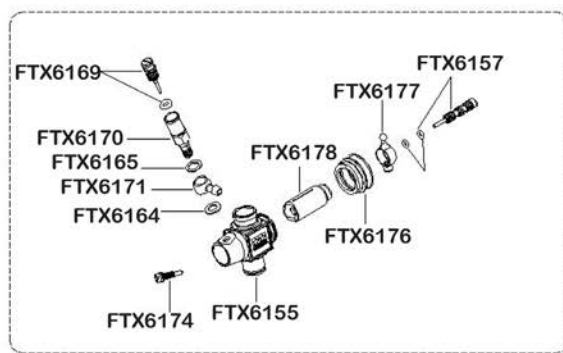

FTX6150	FTX FORCE FC.18 BALL BEARING
FTX6151	FTX FORCE FC.18 BALL BEARING
FTX6152	FTX FORCE FC.18 CRANKCASE
FTX6153	FTX FORCE FC.18 BURN ROOM/NEEDLEHEAD
FTX6154	FTX FORCE FC.18 CASTING CYLINDER HEAD
FTX6155	FTX FORCE FC.18 COMPOSITE CARB MAIN BODY
FTX6156	FTX FORCE FC.18 COMPOSITE CARB COMPLETELY SET
FTX6157	FTX FORCE FC.18 COIL NEEDLE W/Piston
FTX6158	FTX FORCE FC.18 CYLINDER SLEEVE/Piston
FTX6159	FTX FORCE FC.18 CYLINDER/Piston/CONNECTING ROD SET
FTX6160	FTX FORCE FC.18 CONNECTING ROD
FTX6161	FTX FORCE FC.18 90 GRAM/3/4MT
FTX6162	FTX FORCE FC.18 DRIVE BRASS WASHER
FTX6163	FTX FORCE FC.18 GLOW PLUG B4 HOT
FTX6164	FTX FORCE FC.18 WASHER,1PC
FTX6165	FTX FORCE FC.18 WASHER,1PC
FTX6166	FTX FORCE FC.18 CYLINDER HEAD WASH ER 1pc
FTX6167	FTX FORCE FC.18 CARBURETOR O'RING, 2pcs
FTX6168	FTX FORCE FC.18 O'RING, 1pc
FTX6169	FTX FORCE FC.18 MAIN NEEDLE 1/8" O'RING
FTX6170	FTX FORCE FC.18 MAIN NEEDLE VALVE HUB
FTX6171	FTX FORCE FC.18 FUEL NYLON
FTX6172	FTX FORCE FC.18 PISTON GUIDON PIN
FTX6173	FTX FORCE FC.18 CYLINDER HEAD BOLT, 4pcs
FTX6174	FTX FORCE FC.18 ADJUST SCREW
FTX6175	FTX FORCE FC.18 CARB PINCH BOLT
FTX6176	FTX FORCE FC.18 DUST COVER
FTX6177	FTX FORCE FC.18 THROTTLE SCREW CAP
FTX6178	FTX FORCE FC.18 THROTTLE & COUNTER NEEDLE VALVE
FTX6179	FTX FORCE FC.18 O' PIN SNAP RING, 2pcs
FTX6180	FTX FORCE FC.18 PLASTIC PARTS ASSEMBLY W/SCREWS
FTX6181	FTX FORCE FC.18 B PARTS ASSEMBLY W/SCREWS
FTX6182	FTX FORCE FC.18 ONE WAY BEARING SET
FTX6183	FTX FORCE FC.18 STARTING PIN
FTX6184	FTX FORCE FC.18 PRESSURE SPRING
FTX6185	FTX FORCE FC.18 SCREWS, 4pcs

Le FTX Banzai Nitro, une voiture de trail à l'échelle 1/10 prête à rouler

Merci d'avoir choisi le FTX 'Banzai' Ce modèle est monté d'usine, l'électronique est pré installée et réglée pour permettre un démarrage et du plaisir le plus rapidement possible.

This 1/10th scale model has been factory assembled and all electrics installed and set up to make it the easiest possible introduction to the sport of driving RC cars.

Attention: lisez l'intégralité du manuel pour exploiter au mieux la voiture et éviter des dommages mécaniques ou corporels. Ce modèle n'est pas un jouet, il doit être manipulé avec précaution. Utilisé dans de mauvaises conditions, ce modèle peut causer des dommages.

Ce modèle n'est pas fait pour être utilisé par un enfant sans la surveillance directe d'un adulte.

Il est essentiel de lire et de suivre les instructions et les recommandations de ce manuel pour entretenir et faire évoluer votre modèle dans de bonnes conditions.

Mesures de sécurité:

- Vous êtes responsable lors de l'évolution de ce modèle, veillez à ne pas vous mettre en danger, à mettre en danger le modèle ou la propriété d'autrui.
- Ce modèle radiocommandé peut être perturbé par d'autres sources d'onde radio, ce qui peut entraîner la perte momentanée du contrôle de la voiture.
- Age recommandé : 14 ans, ceci n'est pas un jouet, ce produit n'est pas fait pour être utilisé par un enfant sans surveillance.

Suivez consciencieusement les instructions suivantes :

- Ne jamais évoluer avec des batteries d'émission faibles
- Toujours évoluer dans une zone dégagée, loin de la circulation et de la foule
- Ne jamais évoluer dans une rue ou un endroit fréquenté
- Toujours garder le modèle dans son champ de vision
- Gardez hors de portée des enfants tous les composants de petite taille, électriques ou chimiques
- Tenez le modèle hors de portée de l'eau (la rouille peut causer des dommages irréversibles au modèle)
- Faites attention aux pièces en rotations, axes, pignons etc.
- Les débutants doivent prendre conseil auprès de personnes plus expérimentées
- Faites attention lors de l'utilisation des outils
- Attention à ne pas mettre les doigts ou d'autres parties du corps en contact avec les pièces en rotation
- Faites attention lors du transport, de la maintenance ou de la réparation, certaines pièces peuvent être coupantes.
- NE JAMAIS toucher les composants tels que le moteur, le variateur ou les batteries après utilisation, ces pièces peuvent être chaudes
- Lorsque vous changez de fréquence d'émission assurez-vous que les quartz de fréquence sont bien positionnés (RX pour récepteur et TX pour l'émetteur)
- Toujours éteindre en premier la voiture avant l'émetteur
- Vérifiez le bon fonctionnement de la voiture les roues dans le vide (en prenant les précautions nécessaires)
- Prolongez la durée de vie du moteur en le préservant de la surchauffe (la durée de vie du moteur dépend aussi de la fréquence de roulage, des changements rapide de direction avant/arrière, des conditions de roulage difficiles poussière/boue des utilisations abusives tirer/pousser des objets)

Contents:

FTX Banzai Nitro RTR Street Car
Transmitter: 2.4ghz Steerwheel

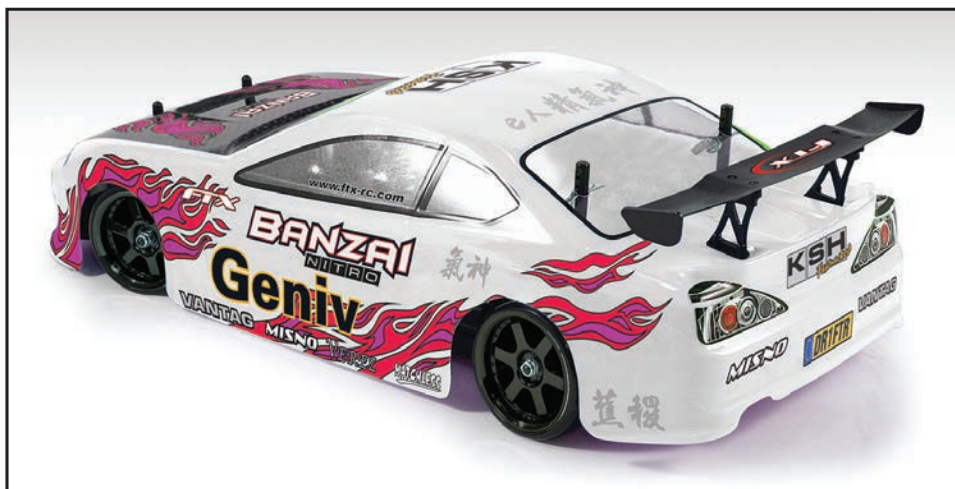



ÉLÉMENTS NON INCLUS MAIS ÉQUIPEMENT NÉCESSAIRE AU FONCTIONNEMENT



x 8 piles AA Batterie

FAST63 Huile de Filtre à Air



Un chauffe bougie

Une pipette d'essence



De l'essence

OUTILS RECOMMANDÉS POUR LA RÉALISATION

FAST615
Fastrax Set de 6 Tournevis Team Tools



Comprend 1.5mm,
2.0mm, 2.5mm,
3.0mm Tournevis Hexa,
plat & phillips Tournevis.

FAST625 Cross Wrench
clé cruciforme avec cinq tailles : 7, 8, 10, 12
et 17 mm



FAST692E
chauffe bougie avec accu et chargeur, clé 8, 9, 10,
12, 17 mm, clé 4, 4.5, 5.5, 7mm, Tournevis
cruciforme, Tournevis plat, Pipette

DÉCOUVERTE DE VOTRE TÉLÉCOMMANDE

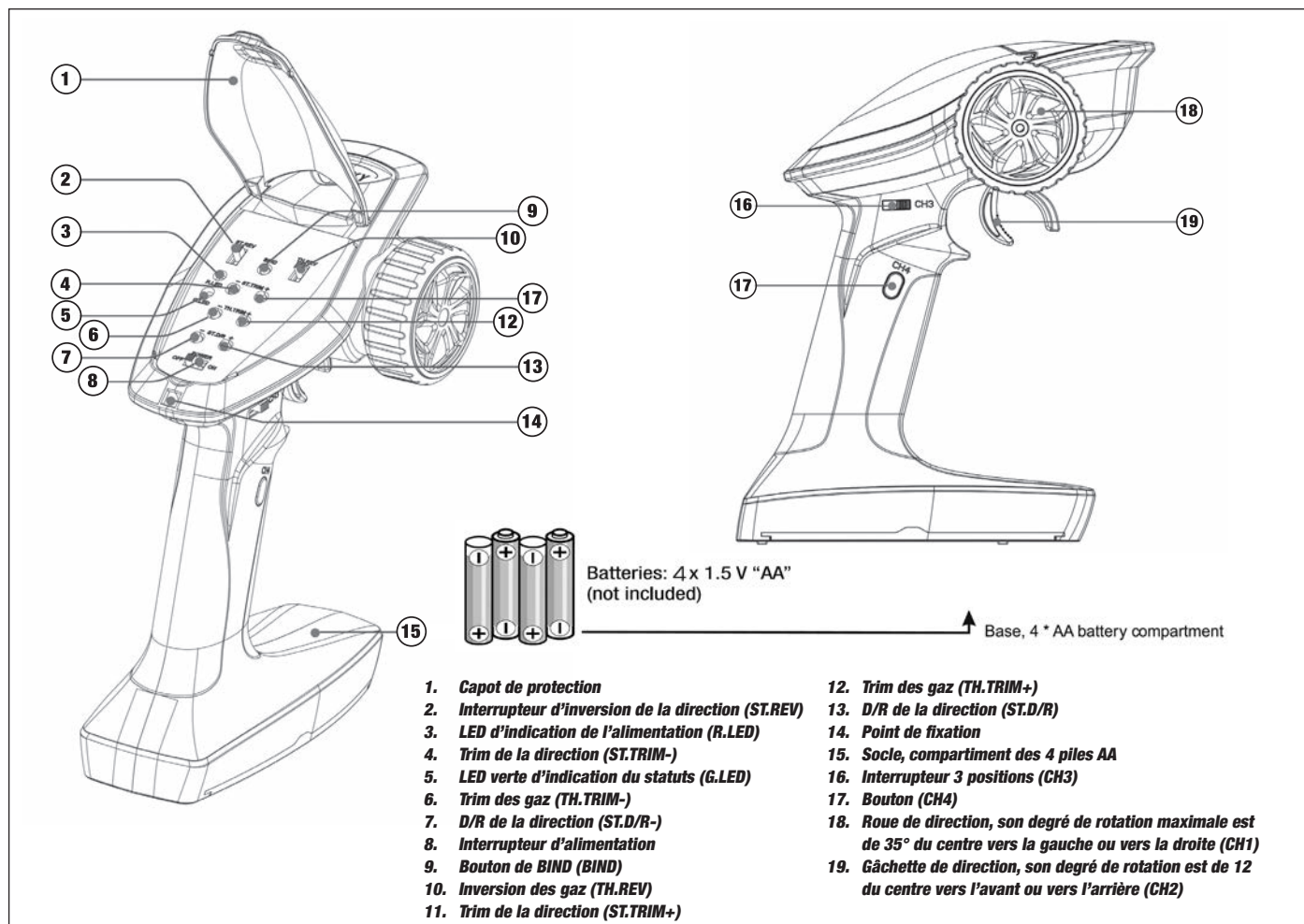

- | | |
|--|--|
| <ol style="list-style-type: none"> 1. Capot de protection 2. Interrupteur d'inversion de la direction (ST.REV) 3. LED d'indication de l'alimentation (R.LED) 4. Trim de la direction (ST.TRIM-) 5. LED verte d'indication du statuts (G.LED) 6. Trim des gaz (TH.TRIM-) 7. D/R de la direction (ST.D/R-) 8. Interrupteur d'alimentation 9. Bouton de BIND (BIND) 10. Inversion des gaz (TH.REV) 11. Trim de la direction (ST.TRIM+) | <ol style="list-style-type: none"> 12. Trim des gaz (TH.TRIM+) 13. D/R de la direction (ST.D/R) 14. Point de fixation 15. Socle, compartiment des 4 piles AA 16. Interrupteur 3 positions (CH3) 17. Bouton (CH4) 18. Roue de direction, son degré de rotation maximale est de 35° du centre vers la gauche ou vers la droite (CH1) 19. Gâchette de direction, son degré de rotation est de 12 du centre vers l'avant ou vers l'arrière (CH2) |
|--|--|

Vue générale du récepteur

Afin d'assurer le meilleur signal possible, positionnez le récepteur de manière à ce que l'antenne soit positionnée vers le haut.

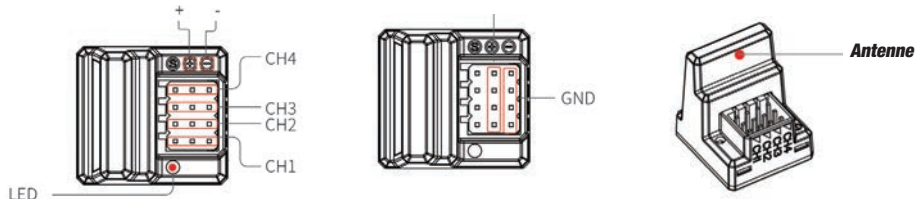

Installation des piles

1. Ouvrez le couvercle du compartiment des piles
2. Insérez 4 piles AA entièrement chargées dans le compartiment tout en vérifiant bien les polarités et leur bon montage.
3. Remettez en place le couvercle

NOTE :

La télécommande possède une alarme en cas de faible tension : Lorsque les piles sont en dessous de 4.2V, la G.LEC sur tableau de bord va clignoter lentement.

Liaison du récepteur et de la télécommande (BIND)

Afin d'assurer le meilleur signal possible, positionnez le récepteur de manière à ce que l'antenne soit positionnée vers le haut.

La télécommande et le récepteur ont déjà été reliés en usine.

1. Allumez la télécommande tout en maintenant le bouton BIND pour entrer dans le mode bind. La G.LED va clignoter rapidement. Une fois dans le mode bind, vous pouvez relâcher le bouton de bind.
2. Le récepteur va automatiquement rentrer en mode bind lorsque vous allez l'allumer.
3. Lorsque la liaison est effectuée, la LED du récepteur va clignoter lentement et la LED de la télécommande va rester allumer une fois redémarrée.

NOTE:

Lors de la liaison, mettez d'abord la télécommande en mode bind puis le récepteur.

Calibration des commandes

Cette fonction permet de déterminer la position neutre de la gâchette des gaz et du volant de direction.

Chaque télécommande est calibrée avant de partir de l'usine, cependant si vous avez besoin de la recalibrer, voici les étapes à suivre :

1. Tournez au max le volant dans le sens des aiguilles d'une montre, poussez au max la gâchette des gaz vers l'avant et allumez la télécommande pour entrer dans le mode de calibration. Les LED R.LED et G.LED vont flasher 2 fois.
2. Calibration de la direction : Tournez au max le volant dans le sens des aiguilles d'une montre puis à fond dans le sens inverse aux aiguilles d'une montre. Lorsque cette calibration est terminée, la R.LED va s'éteindre.
3. Calibration des gaz : Tirez au max la gâchette des gaz vers l'arrière puis à fond vers l'avant.

Lorsque cette calibration est terminée, la G.LED va s'éteindre.

4. Une fois la calibration effectuée, appuyer sur le bouton de bind pour sauvegarder et quitter.



GESTION DE VOTRE VOITURE

1. METTRE SUR ON INTERRUPTEUR

L'ensemble variateur/ récepteur se situe sur ON comme montré sur la photo.



2. METTRE LA RADIO SUR ON

Mette le bouton d'allumage de la radio sur ON. Votre voiture est automatiquement appairer avec votre radio.



3. ASSURE UNE BONNE PERFORMANCE DE PILOTAGE

CENTRE

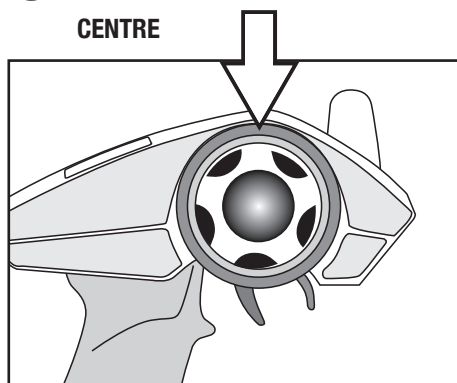

1. Pour que la voiture aille droite ne pas tourner le volant (le laisser au centre).

TOURNE À DROITE

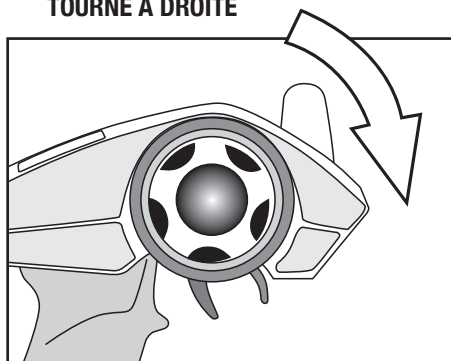

2. Tourner à droite pour permettre à votre d'aller à gauche.

TOURNE À GAUCHE

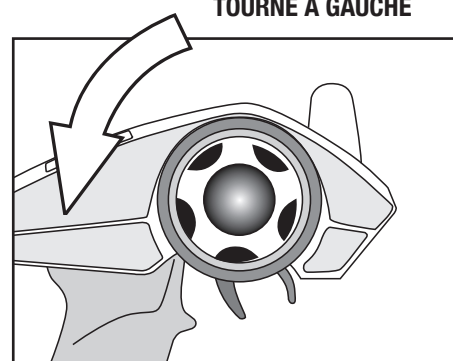

3. Tourner à gauche pour permettre à votre voiture d'aller à droite.

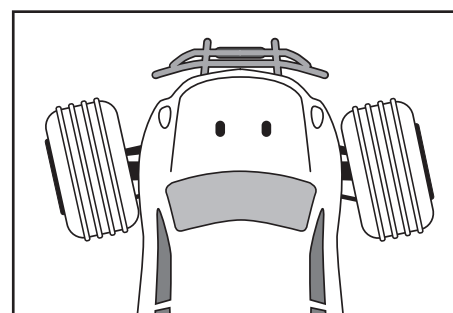
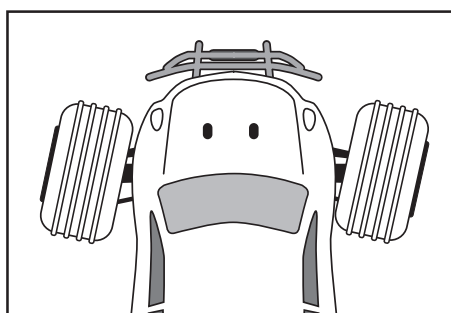
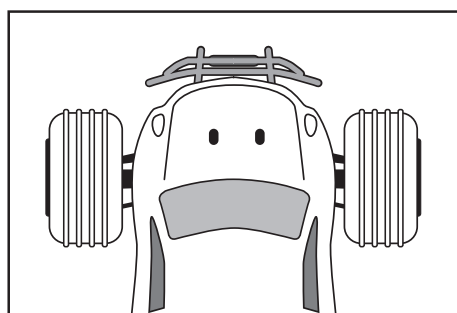

4. VÉRIFIER LA REEPPONSE DE LA GACHETTE

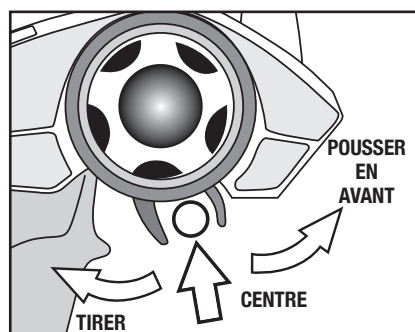

S'IL VOUS PLAÎT NOTEZ :
LE MODÈLE PASSE ENTRE LA MARCHÉ AVANT ET ARRIÈRE INSTANTANÉMENT POUR UNE MANŒVRABILITÉ À FAIBLE VITESSE. UNE UTILISATION EXCESSIVE DE CETTE FONCTIONNALITÉ PEUT ET VA ENDOMMAGER LA TRANSMISSION ET L'ESC.

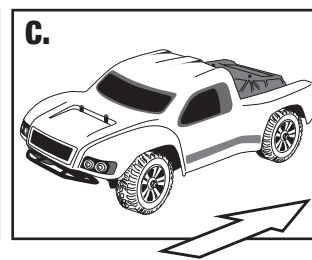
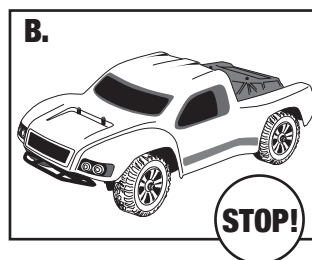
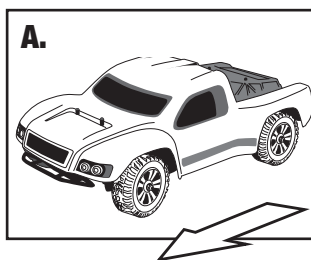

A. Tirer la gâchette en arrière pour accélérer? La lâcher pour décélérer et la pousser pour freiner.

B. Pour arrêter la voiture, lâchette jusqu'au neutre.

C. Pousser la gâchette vers l'avant active la marche arrière.

GESTION DE VOTRE VOITURE

5. RÉGLAGE DU TRIM DE DIRECTION

Accélérez tout doucement afin de faire lentement avancer la voiture. Appuyez-en même sur les boutons droit et gauche pour régler l'orientation des roues afin que la voiture avance tout droit.



STEERING

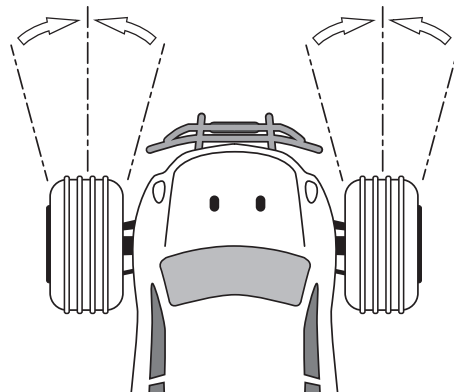

6. RÉGLAGE DU TRIM D'ACCÉLÉRATION

Le bouton de trim d'accélérateur est utilisé pour régler le régime de ralenti de la voiture.

INDICATEUR LED:

- Lorsque vous utilisez les boutons de réglage du trim, la LED clignote lentement pour un appui court et rapidement pour un appui long.
- Quand la valeur du trim est au milieu, la LED clignote 2 fois lentement
- Quand la valeur du trim est au maximum vers la droite ou vers la gauche, la LED ne clignote pas



THROTTLE TRIM

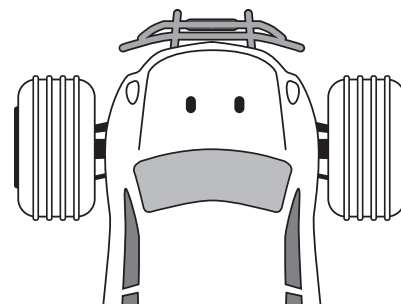

7. RÉGLAGE DES BUTÉES DE DIRECTION

Le bouton noté « ST/DR » est utilisé pour régler les fins de course du servo de direction

Ajustable de 0 à 120% (100% par défaut), une pression du bouton change la valeur de 5%

ST.D / R + : Augmente la course de direction

ST.D / R - : Réduit la course de direction

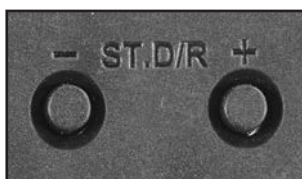

STEERING D/R

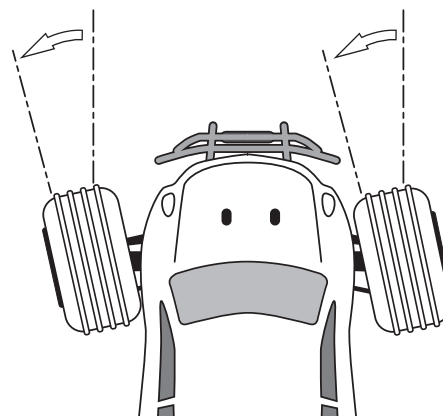

INDICATEUR LED :

- Lorsque vous utilisez les boutons de réglage du trim, la LED clignote lentement pour un appui court et rapidement pour un appui long.
- Quand la valeur du trim est au maximum la LED ne clignote pas.

8. INVERSE DU SENS DE ROTATION DE LA DIRECTION ET DE L'ACCÉLÉRATEUR

Inversion de la direction:

Pour changer le sens de rotation de la direction, montez le bouton « ST R/N » pendant quelques secondes jusqu'à entendre un « BIP » sonore, relâchez ensuite le bouton.

Inversion de l'accélérateur:

Cette fonction permet de changer le sens de rotation de l'accélération.

Si le bouton est en bas celle-ci est le sens normal tandis que si il est en haut, elle sera inversée.

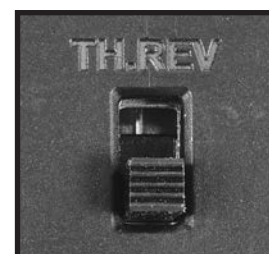
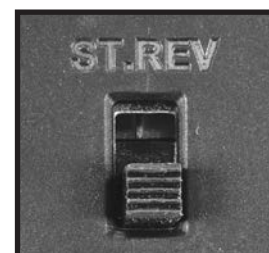



EXPLODED DIAGRAM PARTS LISTING

FRONT & REAR SHOCK ASSEMBLY

FRONT SHOCK

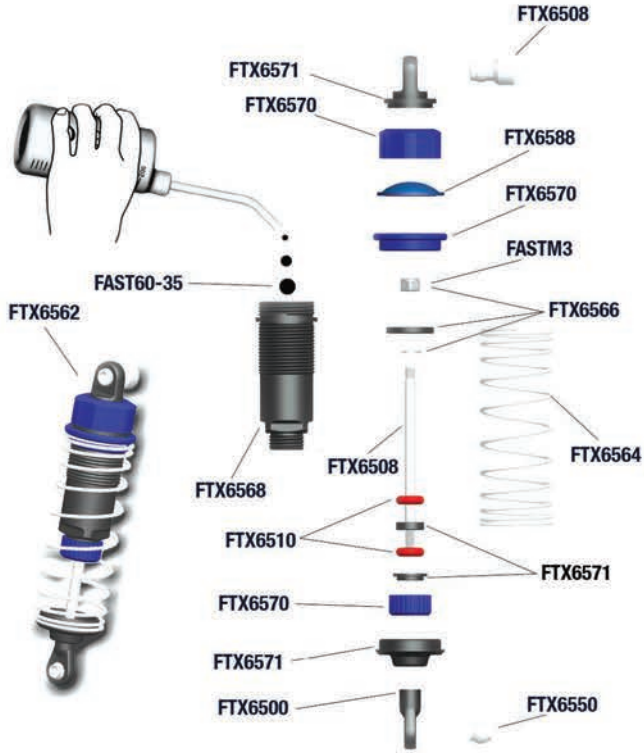

(Dia.3-1)

Assemble front assembly to chassis front.(See Dia. 2-3)

REAR SHOCK

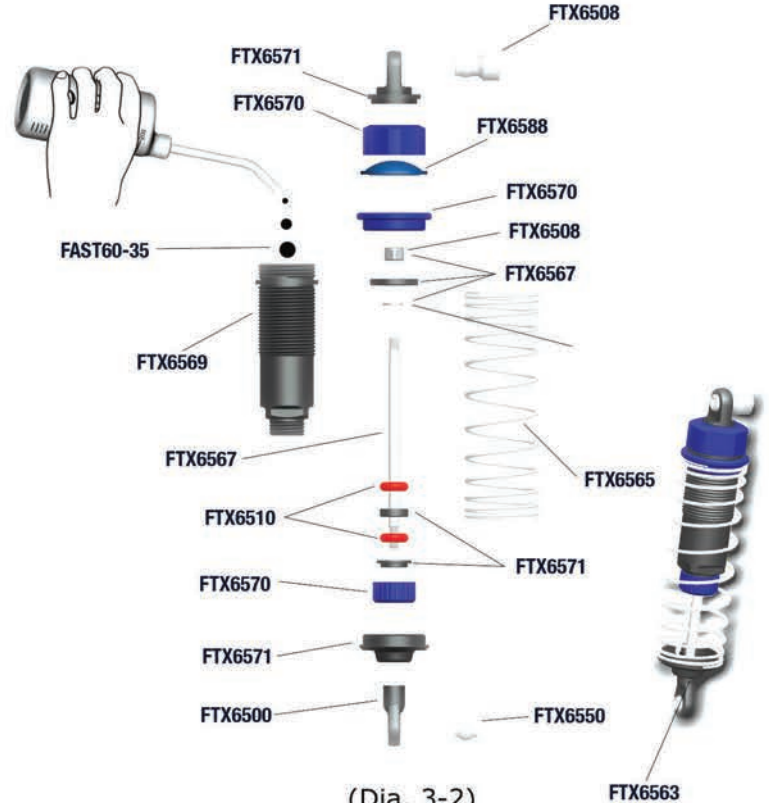

(Dia. 3-2)

Steering Assembly

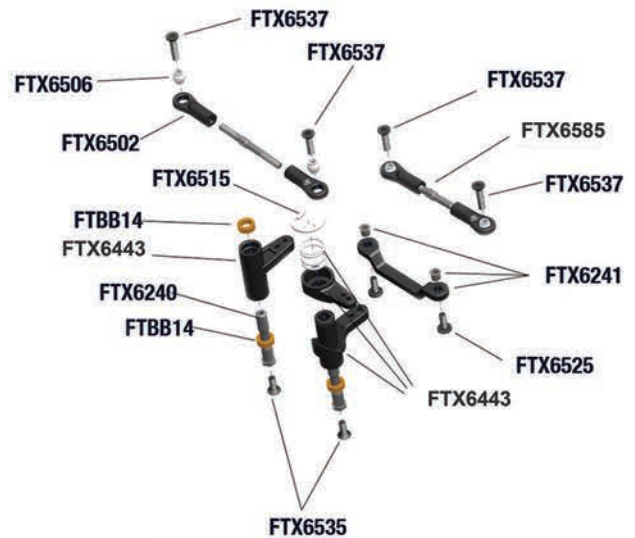

FTX6536 (M3X10)

Mount the wheels
(See Dia. 2-5)



FTX6536 (M3X10)

Assemble Front Bumper Assembly to chassis rear part.(See Dia. 2-4)

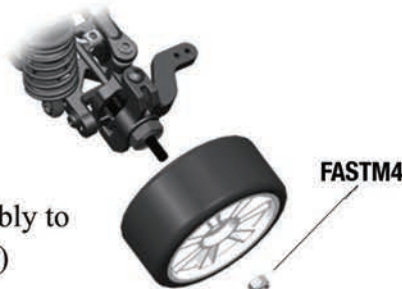

FASTM4



We have optional front and rear sway bar for upgrade which adds higher racing performance,
optional Front & Rear Sway Bar part no: FTX6487

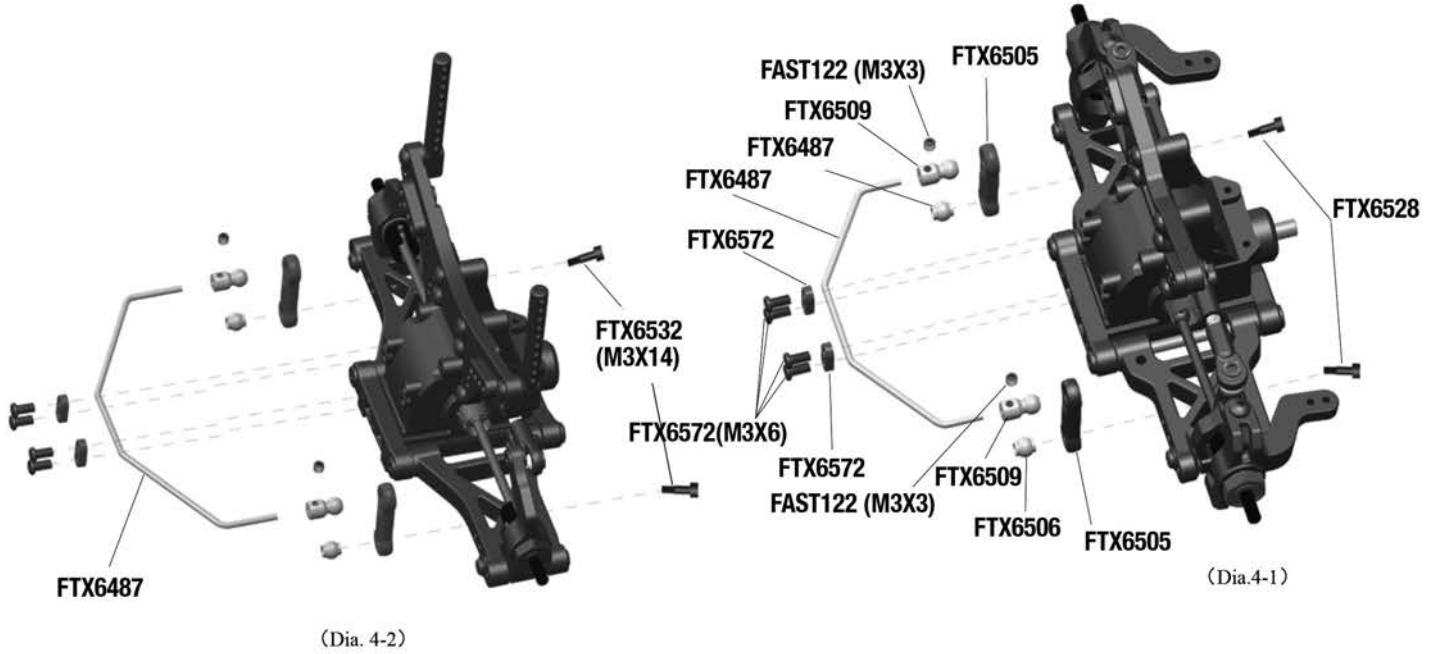

FTX6487

(Dia. 4-2)

(Dia.4-1)

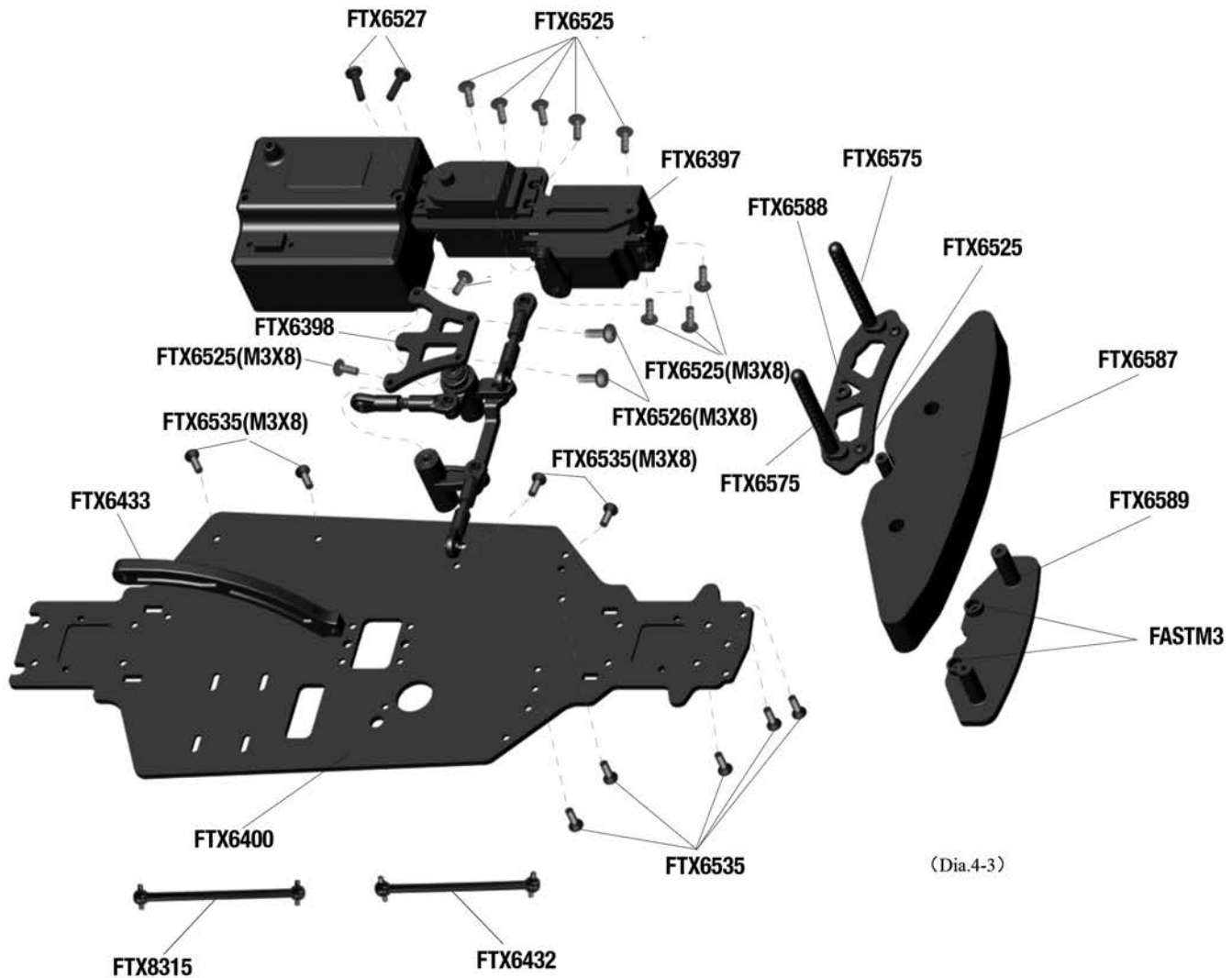

(Dia.4-3)



Throttle Linkage

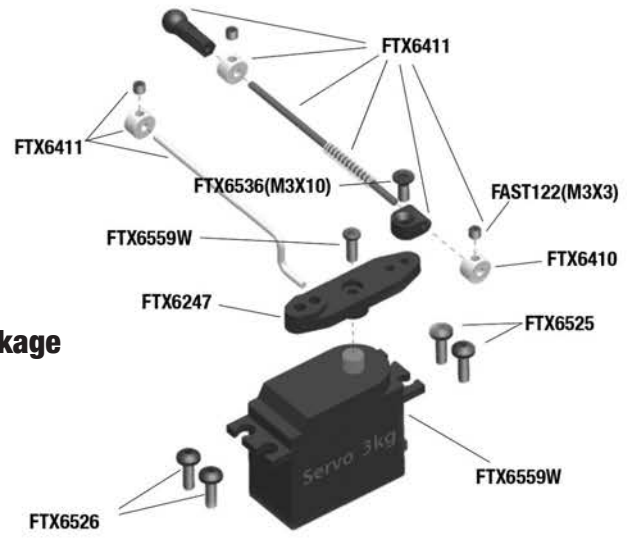

(Dia.6-1)

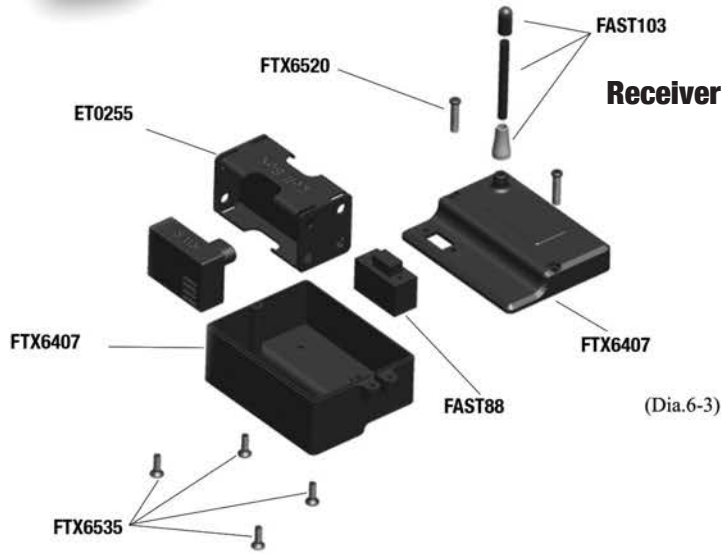

Receiver Assembly

(Dia.6-3)



(Dia.6-2)

Tyres

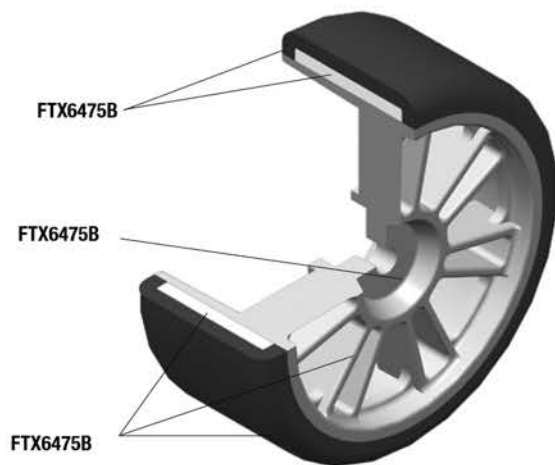

(Dia.6-5)

Fuel Tank



(Dia.6-4)





PARTS LISTING

<p>Diff Gearbox Set 1set</p>  <p>FTX6236</p>	<p>Fuel tank Set 1set</p>  <p>FTX6396</p>	<p>Central Transmission Complete 1Set(Single Speed)</p>  <p>FTX6426</p>	<p>Central Transmission Complete 1Set(Two Speed)</p>  <p>FTX6435</p>
<p>Front Shocks 2pc</p>  <p>FTX6562</p>	<p>Rear Shock Tower 2pc</p>  <p>FTX6563</p>	<p>C clip ϕ8mm 4pcs (for servo Saver)</p>  <p>FTX6515</p>	<p>Uprights 2pc</p>  <p>FTX6216</p>
<p>Rear Drive Shaft 2pc</p>  <p>FTX6213</p>	<p>Front Susp. Holders 2pc</p>  <p>FTX6220</p>	<p>Rear Susp. Holders 2pc</p>  <p>FTX6221</p>	<p>Gearbox Housing Set 2pcs</p>  <p>FTX6225</p>
<p>Diff.Drive Gear w/pin 2sets</p>  <p>FTX6227</p>	<p>Diff Case 2pcs</p>  <p>FTX6228</p>	<p>Diff Drive Gear 2pcs</p>  <p>FTX6230</p>	<p>Diff Bevel Gear S. 4pcs 10T</p>  <p>FTX6231</p>
<p>Diff Bevel Gear B. 4pcs</p>  <p>FTX6232</p>	<p>Diff pin 2pcs</p>  <p>FTX6233</p>	<p>Diff Drive Cup 4pcs</p>  <p>FTX6235</p>	<p>Center Coupler 3pcs</p>  <p>FTX6237</p>
<p>Servo Saver Post 2pcs</p>  <p>FTX6240</p>	<p>Steering Ackerman 1set</p>  <p>FTX6241</p>	<p>Manifold Gasket 6pc</p>  <p>FTX6419</p>	<p>Diff. Drive Gears</p>  <p>FTX6229</p>



<p>Servo & Upper Plate Mounts 1set</p> <p>FTX6401</p>	<p>Fuel Line 2pcs</p> <p>FAST940</p>	<p>Rear Chassis Brace</p> <p>FTX6433</p>	<p>Receiver Box 1set</p> <p>FTX6407</p>
<p>Servo Horns</p> <p>FTX6247</p>	<p>Chassis Brace mount 1pc</p> <p>FTX6409</p>	<p>Stopper 6pcs</p> <p>FTX6410</p>	<p>Throttle Linkage 1set</p> <p>FTX6411</p>
<p>Air filter 1Set</p> <p>FTX6414</p>	<p>Tuned Pipe 1Set</p> <p>FTX6415</p>	<p>Silicone Coupler 1Set</p> <p>FTX6416</p>	<p>Engine mount 2pcs</p> <p>FTX6425</p>
<p>Central Transmission Bulkheads 2pcs</p> <p>FTX6427</p>	<p>Brake Post 1Set</p> <p>FTX6428</p>	<p>Brake Set 1set</p> <p>FTX6429</p>	<p>Brake Cup 2pcs</p> <p>FTX6430</p>
<p>Single Speed Shaft w/pin</p> <p>FTX6431</p>	<p>50T Gear(Single Speed)1pc</p> <p>FTX6424</p>	<p>Two Speed Clutch 1Set (option)</p> <p>FTX6437</p>	<p>Two Speed Shaft 1pc (option)</p> <p>FTX6438</p>
<p>50T Two Speed Gear 1pc (option)</p> <p>FTX6439</p>	<p>45T Two Speed Gear 1pc (option)</p> <p>FTX6440</p>	<p>Shock Ball End 6pcs</p> <p>FTX6500</p>	<p>Servo Link Ball End 6pcs</p> <p>FTX6501</p>



<p>Steering Linkage Ball End 6pcs</p> <p>FTX6502</p>	<p>Sway Bar Holders 6pcs</p> <p>FTX6505</p>	<p>Ball A 6pcs</p> <p>FTX6506</p>	<p>Ball B 6pcs</p> <p>FTX6507</p>
<p>Ball C 6pcs</p> <p>FTX6508</p>	<p>Shock O-ring(Lower) 6pcs</p> <p>FTX6510</p>	<p>Diff O-ring Seal 6pcs</p> <p>FTX6511</p>	<p>Shock Seal Cover 4pcs</p> <p>FTX6512</p>
<p>Pin ϕ 2*10 6pcs</p> <p>FTX6513</p>	<p>One Way Bearing 3pcs</p> <p>FTX6968</p>	<p>Ball Bearing 15*10*4</p> <p>FTBB10</p>	<p>Ball Bearing 10*5*4</p> <p>FTBB120</p>
<p>E clip-2.5mm 6pc</p> <p>FTX6517</p>	<p>Round Head Self Tapping Hex Screw M3*6 6pc</p> <p>FTX6522</p>	<p>Button Head Hex Screw M3*8 6pc</p> <p>FTX6525</p>	<p>Button Head Hex Screw M3*10 6pc</p> <p>FTX6526</p>
<p>Button Head Hex Screw M3*14 6pc</p> <p>FTX6528</p>	<p>H Cap Head Hex Screw M3*14 6pc</p> <p>FTX????</p>	<p>Cap Head Hex Screw M3*18 6pc</p> <p>FAST118</p>	<p>Flat Head Hex M3*8 6pc</p> <p>FTX6535</p>
<p>Flat Head Hex Screw M3*12 6p</p> <p>FTX6537</p>	<p>Flat Head Hex Screw M3*14 6p</p> <p>FTX6538</p>	<p>Flat Head Hex Screw M3*20 6p</p> <p>FTX6540</p>	<p>Flat Head Hex Screw M3*36 6p</p> <p>FTX6541</p>





<p>Clutch Bell(16/21T) 1pc (2-speed Option)</p> <p>FTX6468</p>	<p>Clutch Bell(16T) 1pc</p> <p>FTX6467</p>	<p>Front Shock Tower 1pc</p> <p>FTX6560</p>	<p>Rear Shock Tower 1pc</p> <p>FTX6561</p>
<p>Cap Head Hex Screw M3*20 6pcs</p> <p>FTX-SCH050</p>	<p>Front Shock Spring 2pc</p> <p>FTX6564</p>	<p>Rear Shock Spring 2pc</p> <p>FTX6565</p>	<p>Front Shock Shaft & Piston Set 2sets</p> <p>FTX6566</p>
<p>Rear Shock Shaft & Piston Set 2sets</p> <p>FTX6567</p>	<p>Front Shock Body 2pc</p> <p>FTX6568</p>	<p>Rear Shock body 2pc</p> <p>FTX6569</p>	<p>Steering Knuckle Arm 1set</p> <p>FTX6573</p>
<p>Body Post 1set</p> <p>FTX6575</p>	<p>Sway Bar Fix Plate 6pcs</p> <p>FTX6572</p>	<p>Front Lower Susp.Arm 2pcs</p> <p>FTX6581</p>	<p>Rear Lower Susp.Arm 2pcs</p> <p>FTX6582</p>
<p>Front CVD 2sets</p> <p>FTX6583</p>	<p>Upper Susp.Arm 4pcs</p> <p>FTX6584</p>	<p>Steering Arm 2pcs</p> <p>FTX6585</p>	<p>Servo Linkage 1pc</p> <p>FTX6586</p>
<p>Foam Bumper sponge 1pcs</p> <p>FTX6587</p>	<p>Foam Bumper Plate</p> <p>FTX6588</p>	<p>Lower bumper</p> <p>FTX6589</p>	<p>Hinge Pins(long & short) 1set</p> <p>FTX6595</p>



<p>Touring Tyre Mounted (pr)</p> <p>FTX6475B</p>	<p>Touring tyre & insert 2sets</p>	<p>Touring rim 2pcs</p>	<p>Shock Cap&Adjust Ring 2sets</p> <p>FTX6570</p>
<p>Shock Lower holder 2sets</p> <p>FTX6571</p>	<p>Wheel Hub 4pcs</p> <p>FTX6597</p>	<p>Rear Hub Carrier 2pc</p> <p>FTX6598</p>	<p>Central Dogbone R. 1pc</p> <p>FTX8315</p>
<p>Upper plate 1pc</p> <p>FTX6397</p>	<p>Upper steering plate 1pc</p> <p>FTX6398</p>	<p>Manifold 1Set</p> <p>FTX6399</p>	<p>Chassis plate 1pc</p> <p>FTX6400</p>
<p>Central Dogbone F. 1pc</p> <p>FTX6432</p>	<p>Steering servo post 1pc</p> <p>FTX6434</p>	<p>Switch Cover 2pcs</p> <p>FAST88</p>	<p>Body Clip(Small Size) 6pcs</p> <p>FTX6551</p>
<p>Body Clip(Medium Size) 6pcs</p> <p>FTX6550</p>	<p>Flywheel 1pc</p> <p>FTX6420</p>	<p>Clutch Shoes & Springs</p> <p>FTX6422</p>	<p>Clutch Nut 2pcs</p> <p>FTX6421</p>
<p>Flat Head Hex Screw M3*10 8p</p> <p>FTX6536</p>	<p>Flat Head Hex Screw M3*18 3p</p> <p>FTX6539</p>	<p>Ring Self Tapping Screw 3*4 4pc Ring Self Tapping Screw 3*6 6pc</p> <p>FTX6530 FTX6531</p>	<p>Round Head Self Tapping Hex Screw 3*10 8pcs</p> <p>FTX6523</p>



<p>Cap Head Hex Screw M3*10 6pcs</p> <p>FAST115</p>	<p>Button Head Hex Screw M3*12 6pcs</p> <p>FTX6527</p>	<p>Zip Tie 6pcs</p> <p>FTX6417</p>	<p>FC.18 engine 1pc</p> <p>FTX6149</p>
<p>3kg/cm Servo 1pcs</p> <p>FTX6559W</p>	<p>2.4GHz Transmitter 1pc</p> <p>ET1061</p>	<p>Nylon Lock Nut M3 6pc</p> <p>FASTM3</p>	<p>Nylon Lock Nut-M4 6pc</p> <p>FTM4BKF</p>
<p>Set Screw M3*3 6pc</p> <p>FAST122</p>	<p>Set Screw M4*4 6pc</p> <p>FAST123</p>	<p>Button Head Hex Screw M4*10 6pc</p> <p>FTX6543</p>	<p>E clip-4mm 6pc</p> <p>FTTX6516</p>
<p>Diff 16T Gear Washer 6pcs</p> <p>FTX6226</p>	<p>Printed Body (BLUE)</p> <p>FTX6597B</p>	<p>Printed Body (RED)</p> <p>FTX6596</p>	<p>Printed Body (Green)</p> <p>FTX6596G</p>
<p>Printed Body (white)</p> <p>FTX6596W</p>	<p>2.4ghz receiver</p> <p>ET1096</p>	<p>Steering Servo Saver</p> <p>FTX6443</p>	<p>Rear Dogbones 2pcs</p> <p>FTX6593</p>



OPTIONAL EXTRAS PARTS LISTING



FTX6365W – FTX BANZAI WIDE ALUM. WHEEL HUB HEX 4PCS-1SET



FTX6487 – FTX BANZAI SWAY BAR SET



FTX6349 – FTX BANZAI ALUM. BALL BEARING STEERING



FTX6489 – FTX BANZAI FRONT SHOCK TOWER CARBON



FTX4BF – FASTRAX M4 BLUE FLANGED LOCKNUTS (4PCS)



FTX6492 – BANZAI FRONT LOWER SUSP. ARM – ALUMINIUM (2)



FTX6493 – BANZAI REAR LOWER SUSP. ARMS – ALUMINIUM (2)



FTX6494 – FTX BANZAI STEERING KNUCKLE ARM - ALUMINIUM



FTX6360 – FTX BANZAI ALUM. STEERING ACKERMAN (1PC)

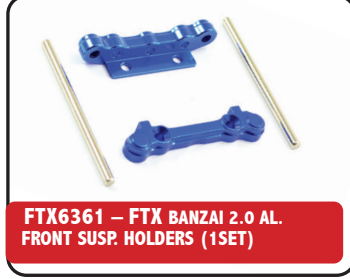

FTX6361 – FTX BANZAI 2.0 AL. FRONT SUSP. HOLDERS (1SET)



FTX6362 – FTX BANZAI 2.0 ALUM. REAR SUSP. HOLDERS 1SET



ET2069 – ETRONIX 15KG/0.16S DIGI WATERPROOF SERVO



FTX6498 – FTX BANZAI FRONT TOURING SHOCK – ALUMINIUM (2)



FAST0097BC – 1/10 TREAD TYRE SET ON 14 SPOKE WHEEL



FTX6368 – FTX CARNAGE 2.0 ALUMINIUM KNUCKLE ARMS (2PCS)



FTX6499 – FTX BANZAI REAR TOURING SHOCK - ALUMINIUM (2)



FTX6490 – FTX BANZAI REAR SHOCK TOWER CARBON



FTX6495 – FTX BANZAI REAR HUB CARRIERS – ALUMINIUM (PR)



FTX6497 – FTX BANZAI FRONT BUMPER COVER - CARBON



FTX6381 – ALUMINIUM TUNED PIPE



FAST692 - FASTRAX NITRO START SET W/TOOLS AND GLOW START



CML DISTRIBUTION LIMITED.SAXON HOUSE, SAXON BUSINESS PARK, HANBURY ROAD, BROMSGROVE. WORCESTERSHIRE. B60 4AD.

BANZAI

NITRO



www.ftx-rc.com



FTX is an exclusive brand of CML Distribution, Saxon House, Saxon Business Park,
Hanbury Road, Bromsgrove, Worcestershire, B60 4AD England.
E-mail: info@ftx-rc.com